



Charging Infrastructure **Titan V3 Maintenance Manual**

Legal Statement

Wanbang Digital Energy Co., Ltd.

No. 39, Longhui Road, Wujin High-tech Zone, Changzhou City, Jiangsu Province Customer service hotline:
400-8280-768

www.starcharge.com

Wanbang Digital Energy Co., Ltd. All rights reserved.

This document is an integral part of the technical document for "Charging Infrastructure" and is copyrighted. Without written consent, any use outside the strict limits of copyright law is prohibited.

This also applies to the files that are copied, translated, and photographed, as well as the files that are stored and processed using electronic media.

Any party who violates this regulation is obliged to compensate for the loss!

Contents

1	Scope.....	1
2	Range of Application	1
3	Requirements for Maintenance	1
3.1	Safety	1
3.2	Normal Requirements	2
3.3	Responsibility.....	2
3.4	Skill Requirements	2
4	Preventive Maintenance.....	3
4.1	Site Inspection	3
4.2	Appearance Inspection.....	4
4.3	Internal Inspection	5
4.4	Insulation Inspection	6
4.5	Functional Check	7
4.6	Cleaning.....	8
4.7	Charging Test	10
5	Corrective Maintenance.....	11
5.1	Assess to the parts inside EVSE	11
5.2	Common Issue	12
5.2.1	Could not Access Web Panel.....	12
5.2.2	No Network Connection	13
5.2.3	EVSE is Offline	15
5.2.4	Power Module Communication Fault.....	16
5.2.5	Meter Fault	20
5.2.6	Input Under-Voltage	21
5.2.7	Input Over-Voltage	21
5.2.8	Insulation Fault	22
5.2.9	Precharge Fault.....	23
5.2.10	Door Sensor Fault.....	24
5.2.11	Emergency Button Fault	25
5.2.12	No output current during charging.....	25
5.2.13	No response after plug in	27

5.2.14	No response after swipe RFID card.....	29
5.2.15	No 230V input	30
5.2.16	Display is not working	31
5.2.17	PDU Fault	32

1 Scope

For the great operation and maintenance management of charger, there is a great management system and safety regulations to ensure the safe, stable, and efficient work of charger.

2 Range of Application

This document is for Titan V3.

3 Requirements for Maintenance

3.1 Safety

- 1) The engineer should master the knowledge of electrical safety, understand the principle and performance of charger, and know what to do if there is an electric shock or some emergencies. So that the engineer can find and deal with various hidden emergencies before the commissioning work.
- 2) When working, the engineer must be sober and concentrated. Do not work if you feel unwell.
- 3) Insulation shoes and gloves must be worn during work. Safety helmet and other protective articles should be worn if necessary. The insulation appliances, instruments and tools must be inspected in good condition and be reliable.
- 4) Any electrical equipment or line shall be deemed to have power and shall not be touched before the power inspection. When contact operation is needed, the equipment should be cut off and checked again. Put a “No closing, someone is working” sign on the power switch handle or take other measures to prevent false closing.
- 5) The power must be cut off before the work.
- 6) The power should be cut off as far as possible. If the engineer must work with the power on, there must be supervisor. The supervisor shall meet the requirements of the profession and shall not engage in operations or do anything unrelated to the monitoring.
- 7) The engineer must distinguish L, N, PE busbar and choose a good station to work. Do not touch the live part and the part connected to N or PE at the same time when working.
- 8) The original wiring and structure in the charger must not be changed without permission and approval.
- 9) After the work is completed, restore all components, check the tools and clean the site.
- 10) When there are some emergencies, immediately start the safety production emergency plan, and immediately report to the relevant person in charge according to the requirements of the plan. Carry out on-site emergency treatment according to the emergency plan within the first time to control the spread and expansion of the accident and rescue personnel and property.
- 11) If there is an electric shock, immediately cut off the power and perform rescue according to the emergency rescue method. At the same time, make emergency calls for professional help and report to

the superior leader, make a record.

- 12) The power transmission sequence is: high-voltage power supply, low-voltage input and output line side, load (box transformer → distribution cabinet → charger);

The power failure sequence is: load, low-voltage input and output line side, high-voltage power supply (charger → distribution cabinet → box transformer).

3.2 Normal Requirements

- 1) The engineer must receive safety production education and job skills training. The engineer can go to work after passing the assessment.
- 2) The engineer must operate in accordance with the operating process and job specifications.
- 3) The engineer must dress uniformly and wear work protective equipment.
- 4) The engineer must be responsible for the work they perform and fulfill their service commitments.

When serving customers, use civilized and standardized terms.

3.3 Responsibility

- 1) The engineer is responsible for the operation and maintenance of the chargers.
- 2) The engineer is responsible for the safe operation of the charging station, improving the safety system of the charging station, conducting periodic safety inspections and supervising and reporting the safety situation of the charging station.

3.4 Skill Requirements

- 1) The engineer must be aware of the charging principle of EV, the working principle of charger, common trouble shooting methods, charger maintenance methods, emergency handling methods and safety knowledge.
- 2) The engineer must understand the relevant rules and regulations of national safety production, and have knowledge of charging safety and emergency treatment methods.

4 Preventive Maintenance

4.1 Site Inspection

Illustration:

The following inspection items are based on Chinese requirements, as well as the frequency and working hours are based on Chinese experience. The overseas regions can adjust according to local requirements and actual conditions.

Requirements:

It is necessary to identify the dangerous source of the charging station site, and report the hidden safety hazard to the place for treatment in time.

Working hours: 10min/site

Frequency: every quarter

Check Item	Content and specification	Check Method	Conclusion	Remark
Station Inspection	There is charging procedure information.	Visually	Pass <input type="checkbox"/> Fail <input type="checkbox"/>	
	CCTV camera works normally.	Visually	Pass <input type="checkbox"/> Fail <input type="checkbox"/>	
	Equipped with fire extinguishers and other safety facilities. Safety facilities are available.	Visually	Pass <input type="checkbox"/> Fail <input type="checkbox"/>	
	Equipped with parking bars.	Visually	Pass <input type="checkbox"/> Fail <input type="checkbox"/>	
	No flammable, explosive and something dangerous around.	Visually	Pass <input type="checkbox"/> Fail <input type="checkbox"/>	
	The surrounding of the station is suitable (no dust, oil, humidity, weeds).	Visually	Pass <input type="checkbox"/> Fail <input type="checkbox"/>	
	The canopy is not damaged.	Visually	Pass <input type="checkbox"/> Fail <input type="checkbox"/>	
	Check that the terrain is leveled, not around flood discharge point.	Visually	Pass <input type="checkbox"/> Fail <input type="checkbox"/>	
Power Distribution Cabinet Check	The surface of the charger is flat and smooth, without obvious mechanical damage or deformation.	Visually	Pass <input type="checkbox"/> Fail <input type="checkbox"/>	
	Warning symbols and electrical hazard signs are complete and clear.	Visually	Pass <input type="checkbox"/> Fail <input type="checkbox"/>	

	The name plate is complete, correct and firm.	Visually	Pass <input type="checkbox"/> Fail <input type="checkbox"/>	
	Cannot open the door after the door is closed and locked.	Visually	Pass <input type="checkbox"/> Fail <input type="checkbox"/>	
	The cabinet body is placed properly on the foundation, and there are no bolts lost or loose.	Visually	Pass <input type="checkbox"/> Fail <input type="checkbox"/>	
	Electrical schematic diagram, qualification certificate, factory inspection report, key.	Visually	Pass <input type="checkbox"/> Fail <input type="checkbox"/>	
	Every breaker's label represents its respective charger	Visually	Pass <input type="checkbox"/> Fail <input type="checkbox"/>	
	The breakers work normally.	Visually	Pass <input type="checkbox"/> Fail <input type="checkbox"/>	
	The power cable is not damaged.	Visually	Pass <input type="checkbox"/> Fail <input type="checkbox"/>	
	The wiring is not loose.	Visually	Pass <input type="checkbox"/> Fail <input type="checkbox"/>	
	Verification of meter data.	Visually	Pass <input type="checkbox"/> Fail <input type="checkbox"/>	
	Check the internal exposed three-phase copper bar protection.	Visually	Pass <input type="checkbox"/> Fail <input type="checkbox"/>	
	Not soaked in water after heavy rain or typhoon.	Visually	Pass <input type="checkbox"/> Fail <input type="checkbox"/>	

4.2 Appearance Inspection

Requirements: Cut input power. Measure the voltage and confirm there is no input.

Working hours: 10min/unit

Frequency: every quarter

Check Item	Content and specification	Check Method	Conclusion	Remark
Appearance checks	All components of the equipment are free from stains, scratches, deformations	Visual	Pass <input type="checkbox"/> Fail <input type="checkbox"/>	
	Name plate and other signages including safety warning signs are accurate, clear and complete	Visual	Pass <input type="checkbox"/> Fail <input type="checkbox"/>	

	Charging cable is complete without damage. No water or dust in the charging connector. The insulation cap is complete	Visual	Pass <input type="checkbox"/> Fail <input type="checkbox"/>	
	LED indicators work normally	Visual	Pass <input type="checkbox"/> Fail <input type="checkbox"/>	
	Emergency stop button should not be pressed	Visual/ Manual	Pass <input type="checkbox"/> Fail <input type="checkbox"/>	

4.3 Internal Inspection

Working time: 20min/unit

Frequency: every six month

Check Item	Content and specification	Check Method	Conclusion	Remark
Internal Check	Charging cabinet, hinge and locks of are functioning normally. The inner components of the cabinet should be free of liquid stains and leakages (from coolants or condensation), rust as well as no signs of physical damages.	Visual/ Manual	Pass <input type="checkbox"/> Fail <input type="checkbox"/>	
	Input and communication terminals are tightened and free from signs of burns.	Visual/ Manual	Pass <input type="checkbox"/> Fail <input type="checkbox"/>	
	PE wire of the cabinet is reliable with no signs of damage and rust	Visual/ Manual	Pass <input type="checkbox"/> Fail <input type="checkbox"/>	
	L1, L2, L3, N, and PE are clearly marked, and the wiring is reliable and in good contact	Visual/ Manual	Pass <input type="checkbox"/> Fail <input type="checkbox"/>	
	Measure three-phase input voltage	Measurement	Pass <input type="checkbox"/> Fail <input type="checkbox"/>	
	No short circuit is present between the DC+ and DC- of the input of charging cable No short circuit is present between the DC+ and DC- of the output of charging cable	Measurement	Pass <input type="checkbox"/> Fail <input type="checkbox"/>	
	No short circuit is present between the DC+ of the input of charging cable and DC+ of the input of charging cable No short circuit is present between the DC- of	Measurement	Pass <input type="checkbox"/> Fail <input type="checkbox"/>	

the input of charging cable and DC- of the input of charging cable			
There should be no reverse connection in DC+/DC- of the input/output of charging cable	Measurement/ Visual	Pass <input type="checkbox"/> Fail <input type="checkbox"/>	
Ensure fireproof material at the bottom is sealed and intact	Visual	Pass <input type="checkbox"/> Fail <input type="checkbox"/>	
Ensure the wiring connections of the AC input main circuit and their screws are tightened properly (such as AC input terminal connector, MCCB, AC contactor, leakage circuit breaker, junction box or terminal, PE wiring and its screws, etc.). If any screw or connection is found loose, a screwdriver must be used to tighten it.	Visual/ Manual/Measurement	Pass <input type="checkbox"/> Fail <input type="checkbox"/>	
Ensure screw and wire connections for DC output circuit, and circuit contact points of various components are tight and in contact (such as power module, PDU output copper wire, DC circuit relay, fuse, charging gun DC terminal, PE wiring, copper plate screw, etc.). If any screw or connection is found loose, a screwdriver must be used to tighten it.	Visual/ Manual/Measurement	Pass <input type="checkbox"/> Fail <input type="checkbox"/>	
Ensure the cotton filter is free of accumulation of particulates and foreign material, and not damaged. Else, replace it.	Visual	Pass <input type="checkbox"/> Fail <input type="checkbox"/>	
Ensure the power module fans are clean and firmly screwed on.	Visual	Pass <input type="checkbox"/> Fail <input type="checkbox"/>	

4.4 Insulation Inspection

Requirements: Cut input power, remove the power modules, remove PE line of surge protector, remove DC+ and DC- of insulation detection module.

Working time: 20min/unit

Frequency: every six month

Check Item	Content and specification	Check Method	Conclusion	Remark
Insulation Performance Check	Ensure resistance of output of DC+ relay to PE is not less than 1 MΩ and record this value.	Measurement	Pass <input type="checkbox"/> Fail <input type="checkbox"/>	
	Ensure resistance of output of DC- relay to PE is not less than 1 MΩ and record this value.	Measurement	Pass <input type="checkbox"/> Fail <input type="checkbox"/>	
	Ensure resistance of L1/L2/L3 to PE is not less than 10 MΩ and record this value.	Measurement	Pass <input type="checkbox"/> Fail <input type="checkbox"/>	

4.5 Functional Check

Requirements: Check when the charger is on.

Working hours: 15min/unit

Frequency: every quarter

Check Item	Content and specification	Check Method	Conclusion	Remark
Functional Check	Start the charging and ensure charging data is properly reflected on the interface	Visual	Pass <input type="checkbox"/> Fail <input type="checkbox"/>	
	During charging, ensure the LED indicators work normally.	Visual	Pass <input type="checkbox"/> Fail <input type="checkbox"/>	
	Charging details such as SOC, charging voltage and current, etc displayed on the charger screen is consistent with the App.	Visual	Pass <input type="checkbox"/> Fail <input type="checkbox"/>	
	Ensure display on the charger screen is easily readable with no signs of cloudiness. The operations and interface should also be smooth and friendly.	Visual	Pass <input type="checkbox"/> Fail <input type="checkbox"/>	
	During charging, opening the charging cabinet should immediately stop the charge automatically and display a warning at the screen.	Visual	Pass <input type="checkbox"/> Fail <input type="checkbox"/>	
	During charging, pressing the emergency stop button should immediately stop the	Visual	Pass <input type="checkbox"/> Fail <input type="checkbox"/>	

	charge automatically and display a warning at the screen.			
	During charging, move the tilt sensor should immediately stop the charge automatically and display a warning at the screen.	Visual	Pass <input type="checkbox"/> Fail <input type="checkbox"/>	
	Setting the upper temperature threshold to below the ambient temperature will result in the charging process to not initiate at all.	Visual	Pass <input type="checkbox"/> Fail <input type="checkbox"/>	
	Ensure that all power modules are working properly where the status and temperature are reflected accordingly.	Visual	Pass <input type="checkbox"/> Fail <input type="checkbox"/>	

4.6 Cleaning

Working hours: 20min/unit

Frequency: every year

Check Item	Content and specification	Check Method	Conclusion	Remark
Cleaning and maintenance	Dustproof cotton / filter	replace		

Replacement Steps:

Inlet Filter Mats:

- 1) Open the door, as shown below, move the clip to remove the filter mats;



- 2) When install the new filter mats, the side without steel wire should be outside;



- 3) If it is hard to move the clip, could use a loose the screws to make it easier to move the clip. Remember to tighten it when you install the new filter mats already.

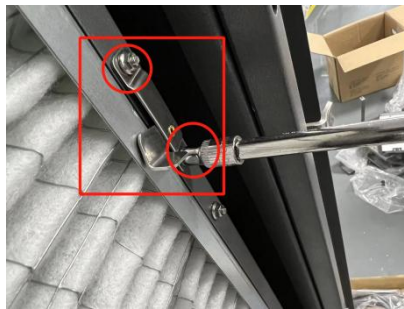

Outlet Filter Net:

- 1) Check the status of fans in advance, if there is damage, replace the fan.



- 2) Remove the 6 screws as shown in the figure below;

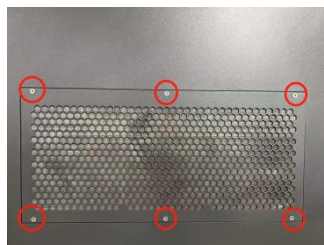

- 3) Clean the filetr net;

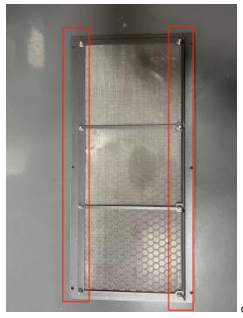

4) Install the filter net back.



4.7 Charging Test

When all the check items have been tested, use the APP to scan the code or swipe the card to start, and the charging time for each charging gun is not less than 10 minutes. and record the data:

Vehicle Model	ID	Required Voltage (V)	Required Voltage (A)	Output voltage (V)	Output current (A)	Output meets the requirements
						Pass <input type="checkbox"/> Fail <input type="checkbox"/>
						Pass <input type="checkbox"/> Fail <input type="checkbox"/>
						Pass <input type="checkbox"/> Fail <input type="checkbox"/>
						Pass <input type="checkbox"/> Fail <input type="checkbox"/>
						Pass <input type="checkbox"/> Fail <input type="checkbox"/>
						Pass <input type="checkbox"/> Fail <input type="checkbox"/>
						Pass <input type="checkbox"/> Fail <input type="checkbox"/>
						Pass <input type="checkbox"/> Fail <input type="checkbox"/>
						Pass <input type="checkbox"/> Fail <input type="checkbox"/>
						Pass <input type="checkbox"/> Fail <input type="checkbox"/>
						Pass <input type="checkbox"/> Fail <input type="checkbox"/>
						Pass <input type="checkbox"/> Fail <input type="checkbox"/>

5 Corrective Maintenance

5.1 Assess to the parts inside EVSE

Only transformer inside is not easy to access, here is the guide:

- 1) Remove the line marked "A". Remove the 2 screws marked "B" and remove the metal plate.

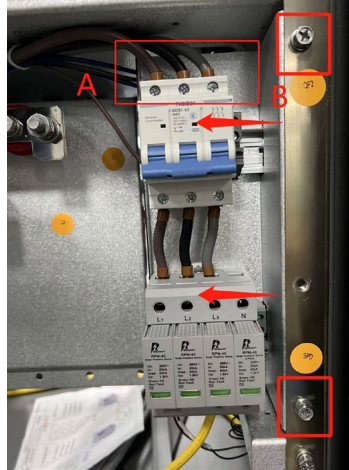

- 2) Remove the line marked "C" and "D".

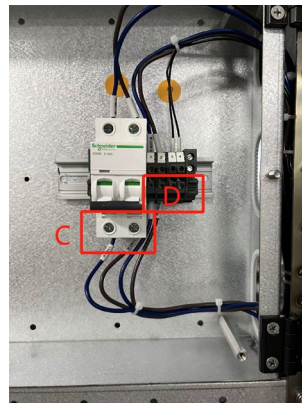

- 3) Cut off the ribbon.



- 4) Remove the screws marked "E", "F" and "G".

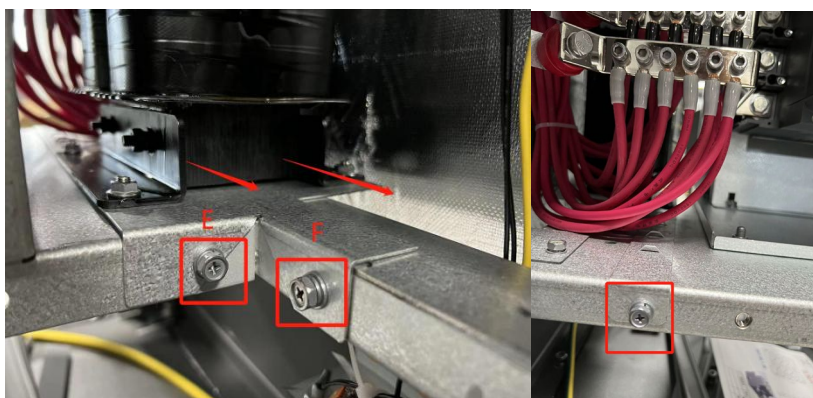

- 5) Loosen the grounding line marked “H”.

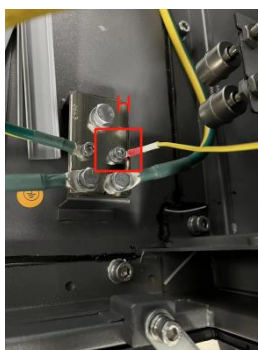

Follow the direction as shown in “E” and “F” to take out the transformer.

5.2 Common Issue

5.2.1 Could not Access Web Panel

Phenomenon:

Could not access web panel (192.168.1.136) successfully.

Analysis:

- 1) Wrong website address;
- 2) IP address of your PC is not configured correctly;
- 3) Unstable LAN connection;
- 4) Hardware issue (A7 core board/A7 board/Router).

Solution:

- 1) Check the IP address setting of your PC;

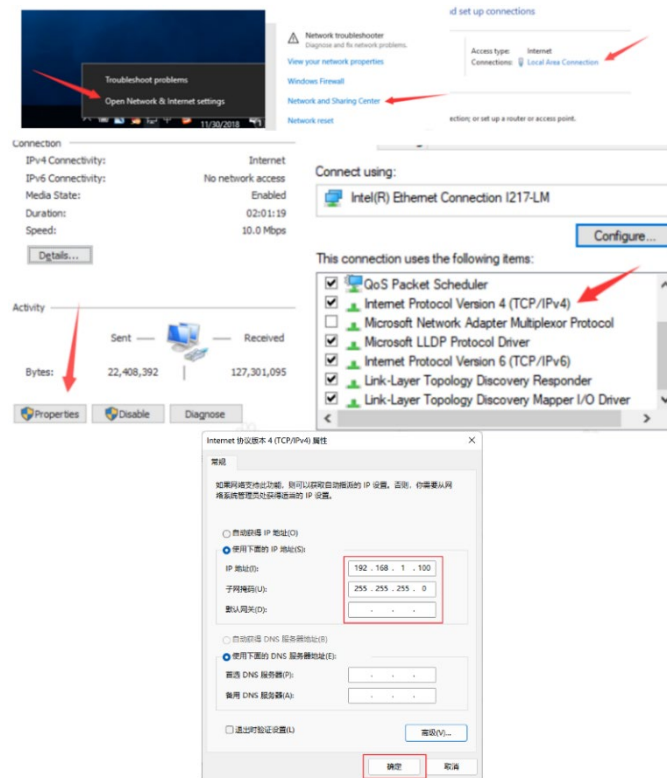

- 2) Check the connection of LAN cable;
- 3) Check whether the LAN cable or your PC itself is workable;
- 4) Change a browser (Edge and Chrome is recommended) or clear the cache and try again;
- 5) Use TF card to burn in software for A7 board again;
- 6) Try to change the Core board or A7 board.

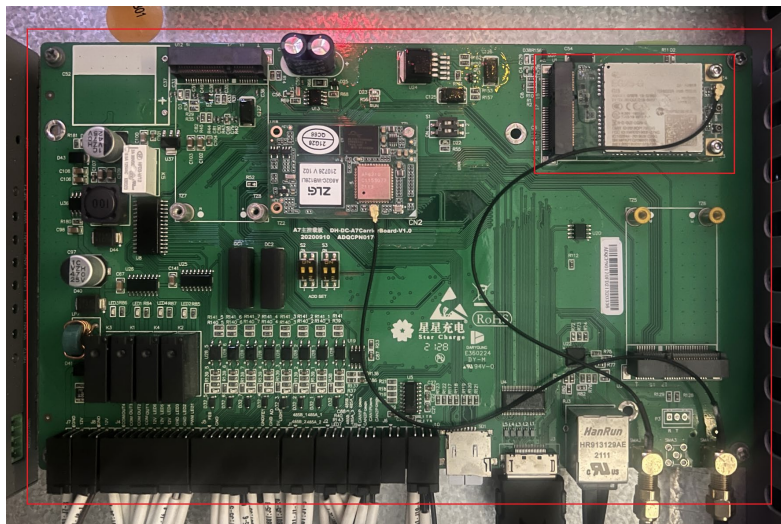

5.2.2 No Network Connection

Phenomenon:

EVSE is offline on the web panel in “Network State”.

Analysis:

- 1) SIM card is not inserted correctly;
- 2) Incorrect APN configuration;
- 3) Unstable 4G signal onsite;
- 4) SIM card is out of charge
- 5) Non-supported frequency band;
- 6) Unstable WIFI signal;
- 7) Unstable LAN connection;
- 8) 4G communication module or A7 board is broken.

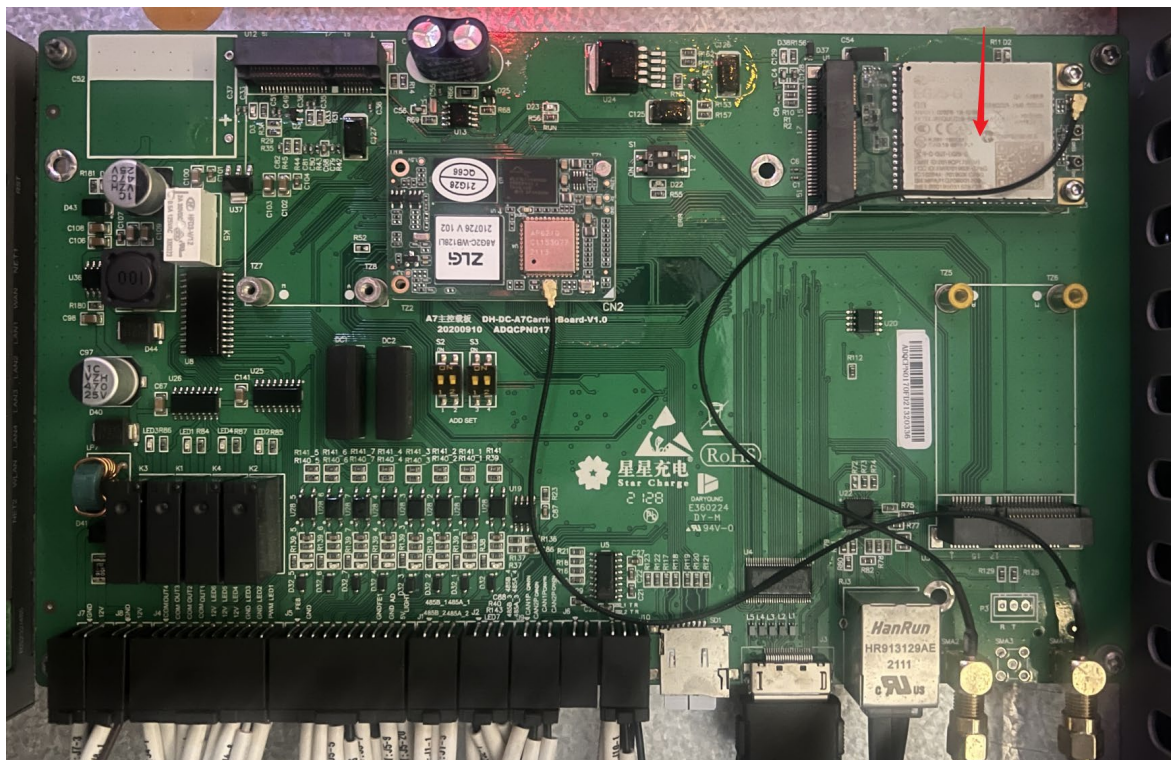

Solution:

If using SIM card:

- 1) Check whether SIM card is inserted correctly. And SIM card should be inserted when EVSE is powered off. If inserting SIM card when EVSE is powered on, rebooting is necessary.
- 2) Check whether the SIM card is workable and APN configuration with SIM card operator and confirm the configuration in web panel.

4G configuration

Enable modification

APN User Psw Pin

3) Check “Strength of 4G” in web panel. (If CSQ<18, the site signal is not stable)

Network state

Link status	Online	Strength of 4G(CSQ)	4	Network card	4G network
-------------	--	---------------------	--	--------------	------------

If using WIFI/Ethernet:

- 4) Connect your phone or you PC with this WIFI or LAN cable to check whether it is connected to network.
- 5) Try to replace 4G communication board or A7 board.

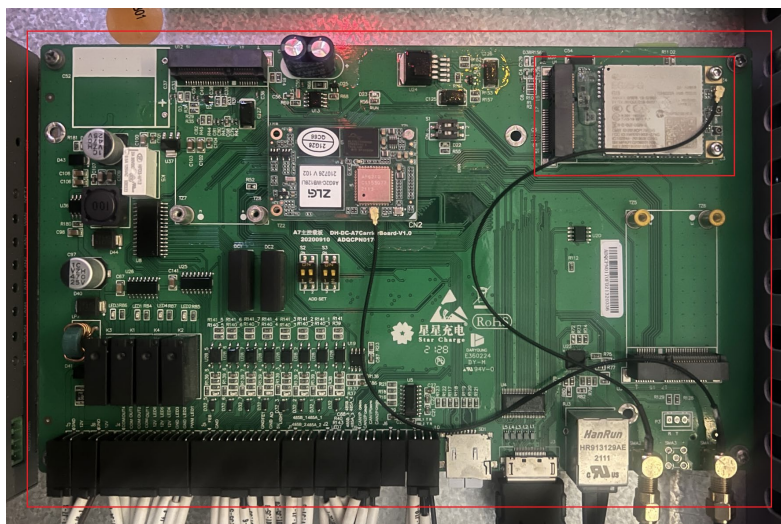

5.2.3 EVSE is Offline

Phenomenon:

- 1) EVSE is offline on the backend.
- 2) “Backend Connection” is “Offline” in the web panel.

State of OCPP

Backend Connection	Offline
--------------------	---

Analysis:

- 1) EVSE is out of power;
- 2) EVSE is not connected to network successfully;
- 3) Backend configuration is not set correctly in web panel or backend;
- 4) 4G communication module or A7 board is broken.

Solution:

- 1) Check whether EVSE is powered on. If not, check whether there is no power.
- 2) Check the network connection;
- 3) Check the OCPP backend and ID configuration with backend.

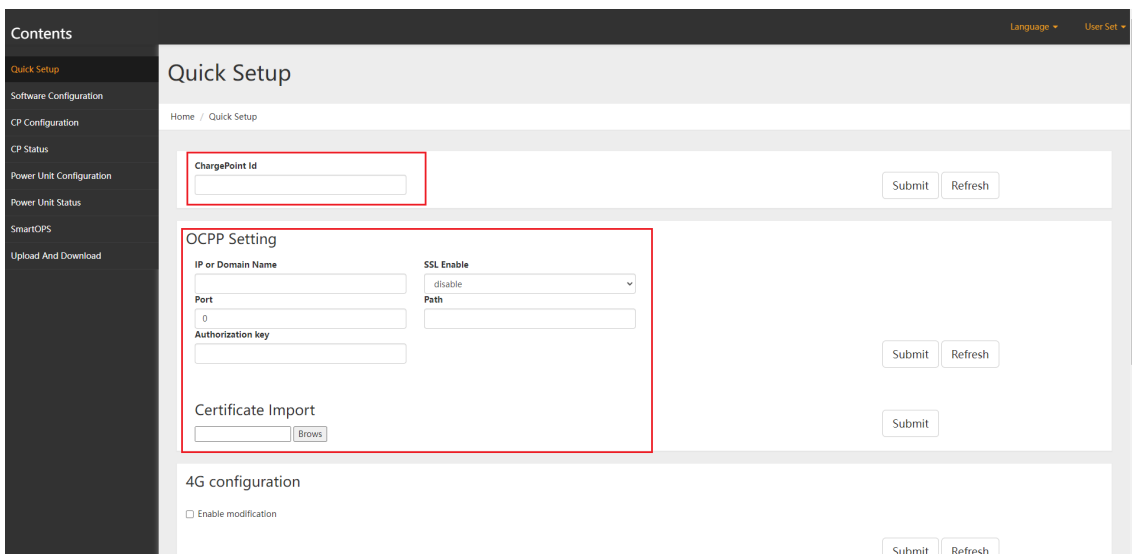

5.2.4 Power Module Communication Fault

Phenomenon:

“Power module communication fault” is shown on the display.

Analysis:



- 1) Power module or power module socket itself is broken;
- 2) Main breaker is broken or tripped;
- 3) AC contactor is broken;
- 4) Power module address is not set correctly;
- 5) Configuration in web panel about power module is incorrect.

Solution:

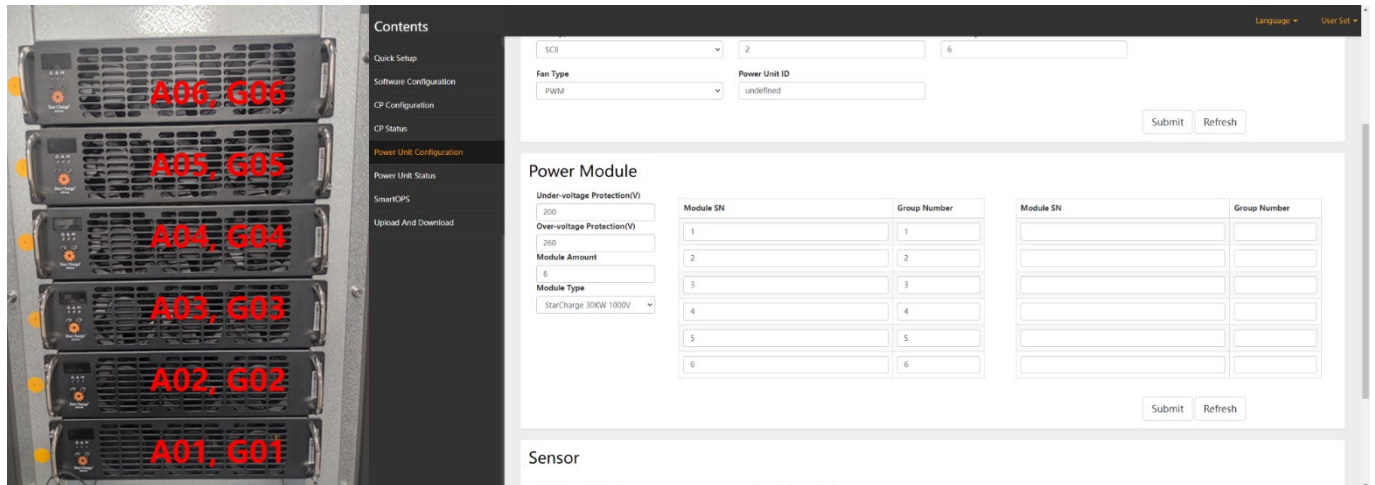
1) Check the power module address and configurations about power module in web panel;



2) Check whether some of the power modules' fault light is on. Follow the checklist below to check it.

Indicator light	Status	Status description	Solutions
Alarm indicator (Yellow) 	On	<ul style="list-style-type: none"> Power derates due to missing phase of AC input and temperature Irregular current sharing 	Check if the input wiring and power distribution switch of the charger or the charging stack cabinet are normal. If the input wiring and power distribution switch of the charger or the charging stack cabinet are normal, but the alarm still exists, replace it
	Flashing	<ul style="list-style-type: none"> Operating under manual mode 	
Alarm indicator (Red) 	On	<ul style="list-style-type: none"> EEPROM Fault Fan drive fault AC Input over/ under voltage Missing phase for AC input Over temperature inside Irregular communication for primary and secondary side Output over/under voltage AC over voltage separation Serial number duplication 	Replace the power module
	Flashing	<ul style="list-style-type: none"> Fans don't work 	

3) Measure the input voltage of EVSE. If abnormal, contact the installation team to check.

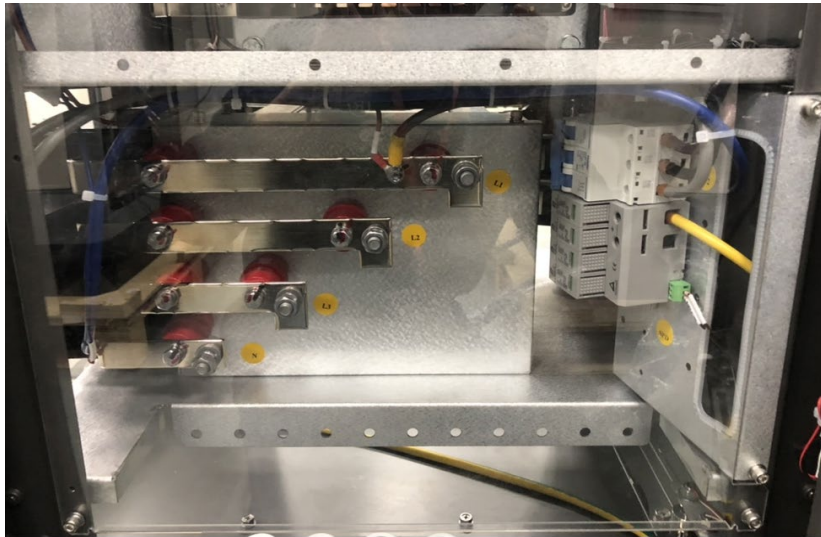

- 4) If input power is normal, check whether the main breaker is tripped. If so, turn it on. If not, measure the input and output voltage (DC 400V, AC 230V) of the main breaker. If no output, replace the main breaker.

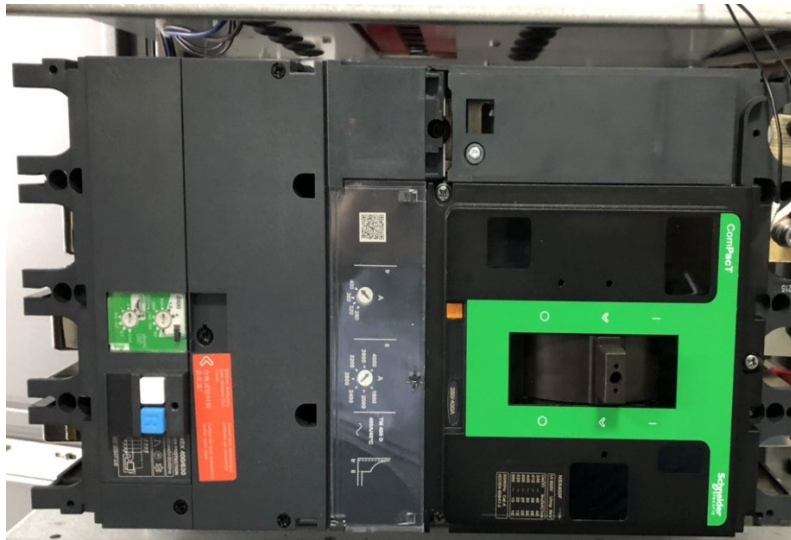

- 5) If main breaker is normal, connect AC relay in web panel (disable door sensor and open AC relay). Measure the input and output voltage (AC 230V) of AC relay. If no output, measure whether there is 230V to AC relay. If so, replace the AC relay. If not, replace the environment monitor board or A7 board.

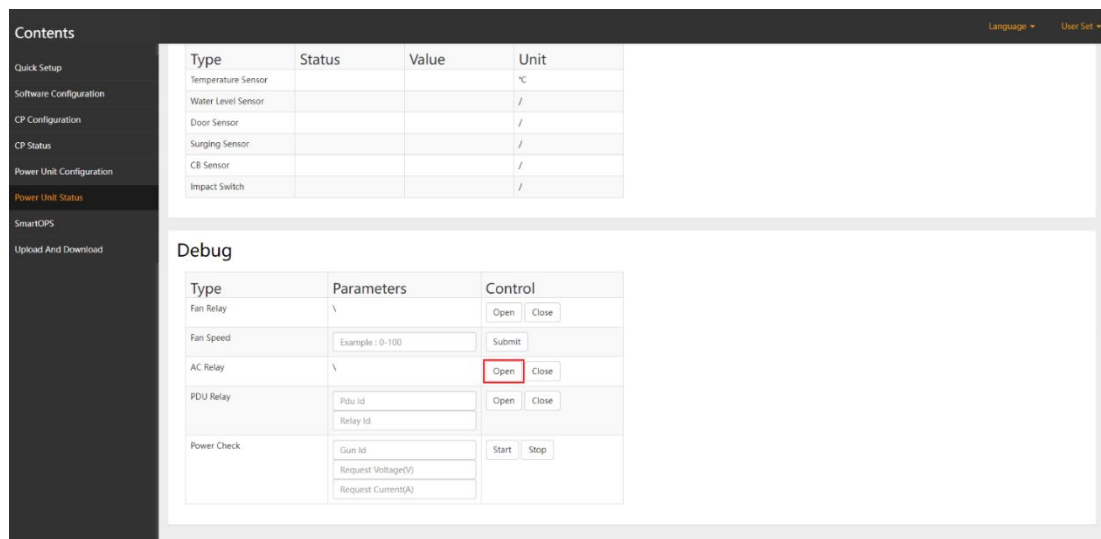
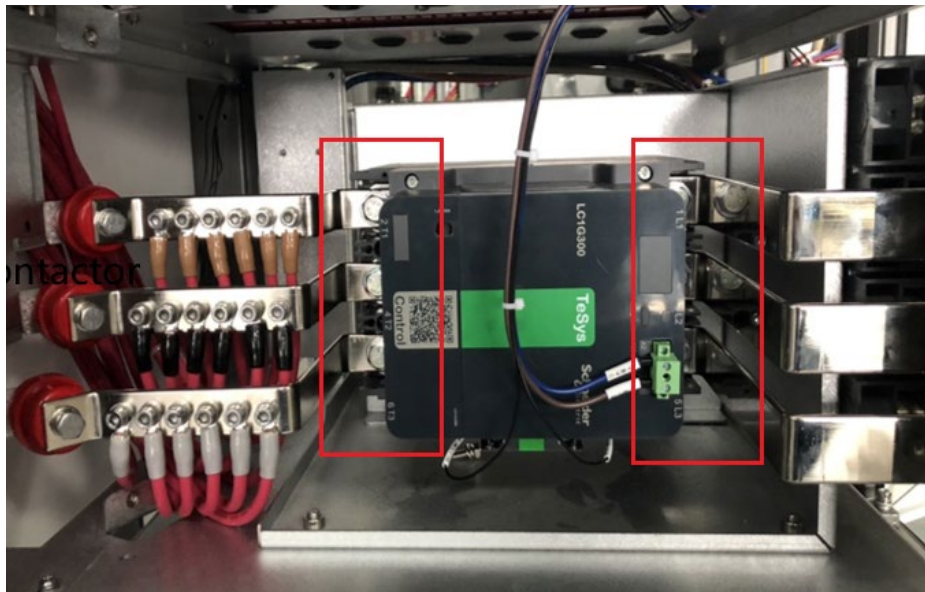

- 6) If AC relay is normal, turn AC relay on in web panel. Check the status of power modules in web panel. If the status of one power module is offline still. Plug in this power module one more time or exchange this power module with another one. If still the same power module is offline, replace it.

Power Module Status	
Power Module1 Group: 1 WorkStatus: Free ReqVol(V): 0.0 ReqCur(A): 0.00 Voltage(V): 0.0 Current(A): 0.00 Temperature(°C): 34.7	Power Module2 Group: 2 WorkStatus: Free ReqVol(V): 0.0 ReqCur(A): 0.00 Voltage(V): 0.0 Current(A): 0.00 Temperature(°C): 35.5
Power Module3 Group: 3 WorkStatus: Free ReqVol(V): 0.0 ReqCur(A): 0.00 Voltage(V): 0.0 Current(A): 0.00 Temperature(°C): 31.8	Power Module4 Group: 4 WorkStatus: Free ReqVol(V): 0.0 ReqCur(A): 0.00 Voltage(V): 0.0 Current(A): 0.00 Temperature(°C): 32.1
Power Module5 Group: 5 WorkStatus: Offline ReqVol(V): 0.0 ReqCur(A): 0.00 Voltage(V): 0.0 Current(A): 0.00 Temperature(°C): -50.0	Power Module6 Group: 6 WorkStatus: Free ReqVol(V): 0.0 ReqCur(A): 0.00 Voltage(V): 0.0 Current(A): 0.00 Temperature(°C): 34.4

- 7) If not, measure the resistance between CANL and CANH of power module socket, 60Ω normally. If abnormal, remove the J9 port on A7 board (CB01), measure the resistance between CANL and CANH of power module socket, 120Ω normally. If abnormal, replace the 120Ω resistor on the power module socket. Measure the resistance between 1&4 pin of J9 port on A7 board, 120Ω normally. If abnormal, replace the A7 board.

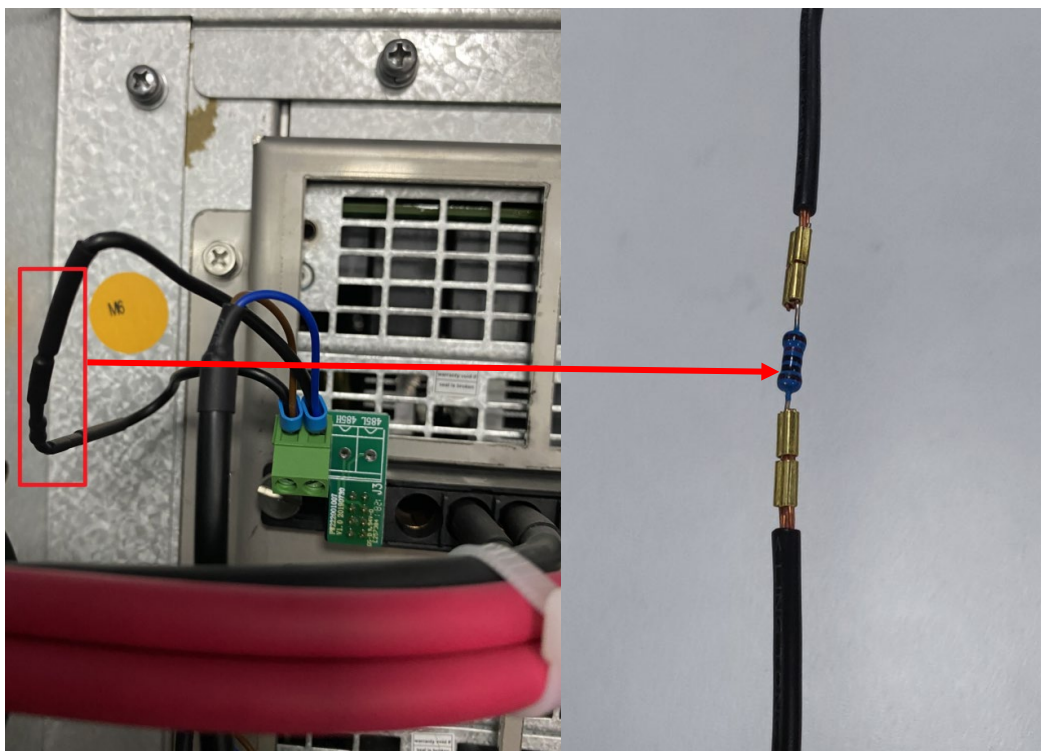
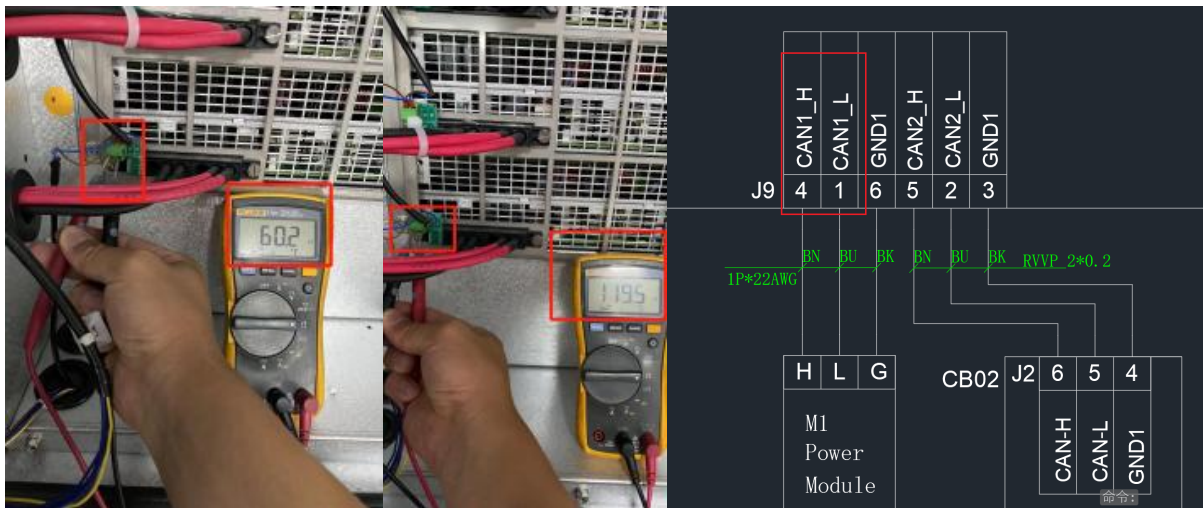

5.2.5 Meter Fault

Phenomenon:

“Meter fault” is shown on the display.

Analysis:

- 1) Meter itself is broken;
- 2) A7 board is broken;
- 3) The communication line between meter and A7 board is unstable.

Solution:

- 1) Check whether the meter is power on. If not, check the input power.
- 2) Check the communication line between meter and A7 board.

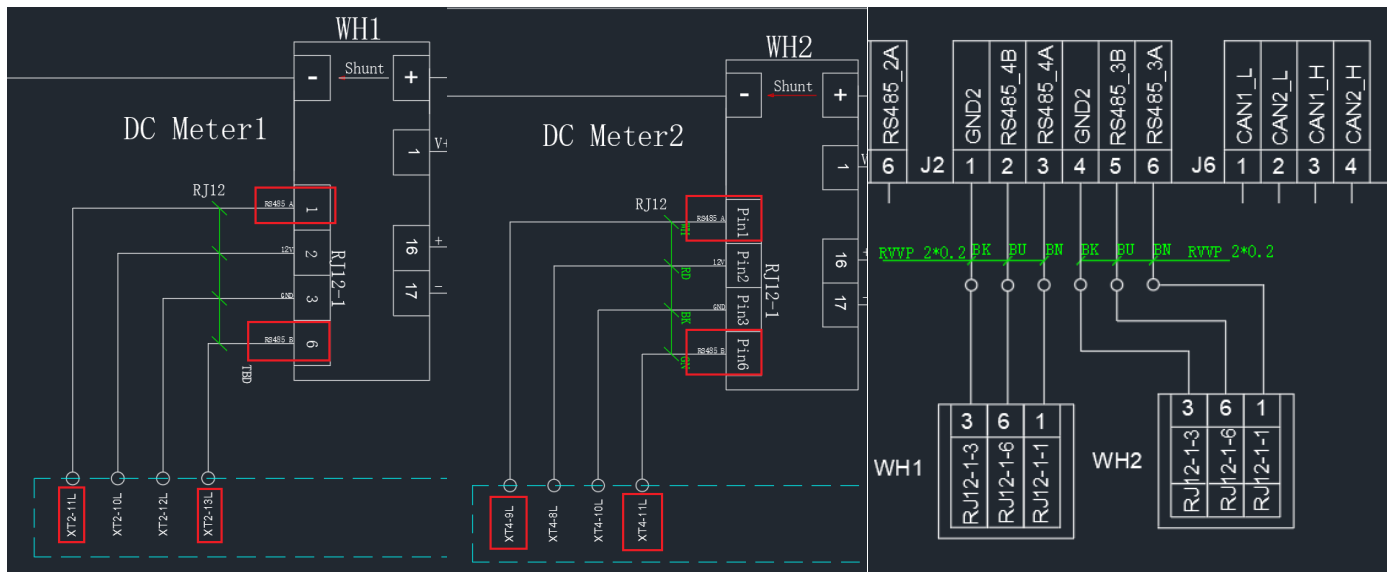

- 3) Replace the A7 board or meter.
- 4) Send log file to Star Charge for analysis.

5.2.6 Input Under-Voltage

Phenomenon:

“Input under voltage” is shown on the display.

Analysis:

- 1) The input voltage is over 400V-10%
- 2) Power module is broken.

Solution:

- 1) Measure the input voltage, if abnormal, contact the installation team.
- 2) Monitor whether there are some power modules error during charging. If so, try to replace it.

5.2.7 Input Over-Voltage

Phenomenon:

“Input over voltage” is shown on the display.

Analysis:

- 1) The input voltage is over 400V+10%
- 2) Power module is broken.

Solution:

- 1) Measure the input voltage, if abnormal, contact the installation team.
- 2) Monitor whether there are some power modules error during charging. If so, try to replace it.

5.2.8 Insulation Fault

Phenomenon:

“Insulation fault” is shown on the display.

Analysis:

- 1) Something wrong with the charging connector;
- 2) The circuit is abnormal;
- 3) The insulation detection module is broken;
- 4) The power module is broken.

Solution:

- 1) Check whether there is water, stone or something inside the charging connector. If so, clean or dry it.
- 2) Measure the insulation resistance of input power cable and charging connector as the steps during commissioning. Correct the components with issue.



- 3) Check the wiring of insulation detection module.

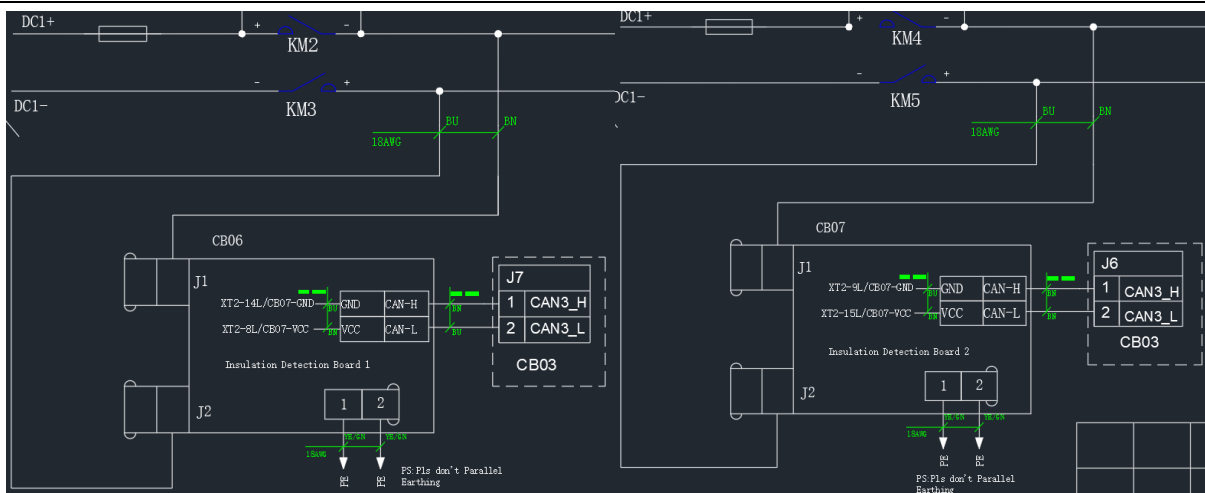

- 4) Monitor the power module during charging, whether some of them no voltage increase, if so, replace the broken power module.
- 5) Send log file to Star Charge for analysis.

5.2.9 Precharge Fault

Phenomenon:

“Precharge fault” is shown on the display.

Analysis:

- 1) Something wrong with the charging connector;
- 2) The circuit is abnormal;
- 3) The precharge board is broken;
- 4) EV-EVSE communication fault.

Solution:

- 1) Check whether there is water, stone or something inside the charging connector. If so, clean or dry it.
- 2) Check the wiring of precharge board;

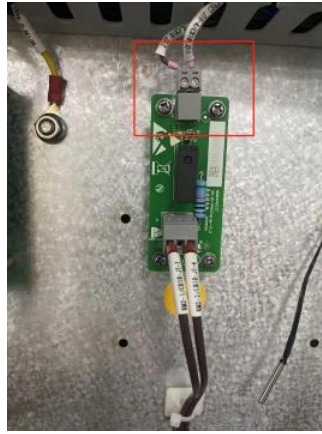

- 3) Enable pre-charge function in web panel;
- 4) Send log file to Star Charge for analysis.

5.2.10 Door Sensor Fault

Phenomenon:

“Door is open” is shown on the display.

Analysis:

- 1) Door is open when door sensor is enable;
- 2) Door sensor is broken;
- 3) Structural issue.

Solution:

- 1) If the door is open when door sensor is enabled. Close the door or disable door sensor;
- 2) Check the wiring on the door sensor;

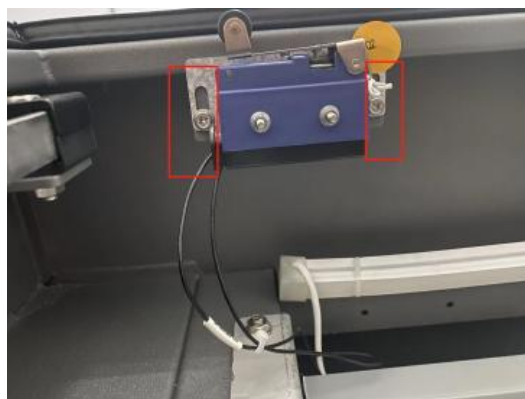

- 3) Check the wiring on A7 board (CB01);

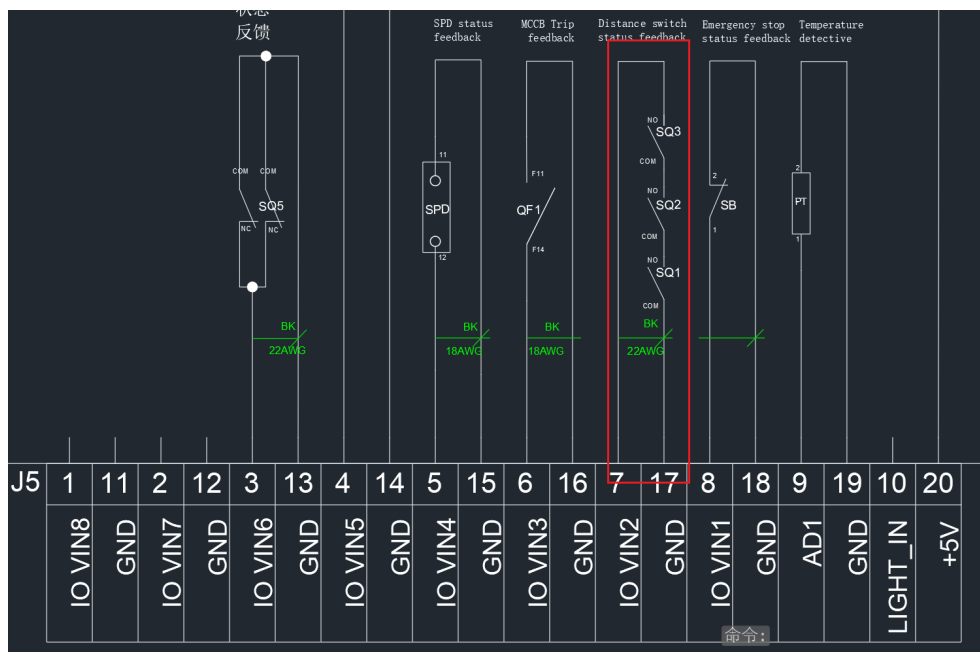

- 4) Check the distance between the door sensor and the door when the door is closed. If too far, try to install the door sensor bit outside.
- 5) Replace the door sensor or A7 board.

5.2.11 Emergency Button Fault

Phenomenon:

“Emergency Button Failure” is shown on the display.

Analysis:

- 1) Emergency button is pressed;
- 2) Emergency button is broken;
- 3) The circuit line is broken.

Solution:

- 1) Check whether the emergency button is pressed. If so, reset it.
- 2) 万用表测量急停按钮常开，常闭有无异常，如若不对，将急停按钮更换；
- 3) 万用表测量急停上线路是否和钣金断路，有无接错现象，如若线路异常将之更改；
- 4) 若上述情况都检查无误，尝试更换主板测试。

5.2.12 No output current during charging

Phenomenon:

There is required current but no output current during charging.

Analysis:

- 1) Output relay is broken;
- 2) The circuit is abnormal;
- 3) Fuse protector is broken;
- 4) Power module is broken;
- 5) EV issue.

Solution:

- 1) Check the wiring on the output relays.

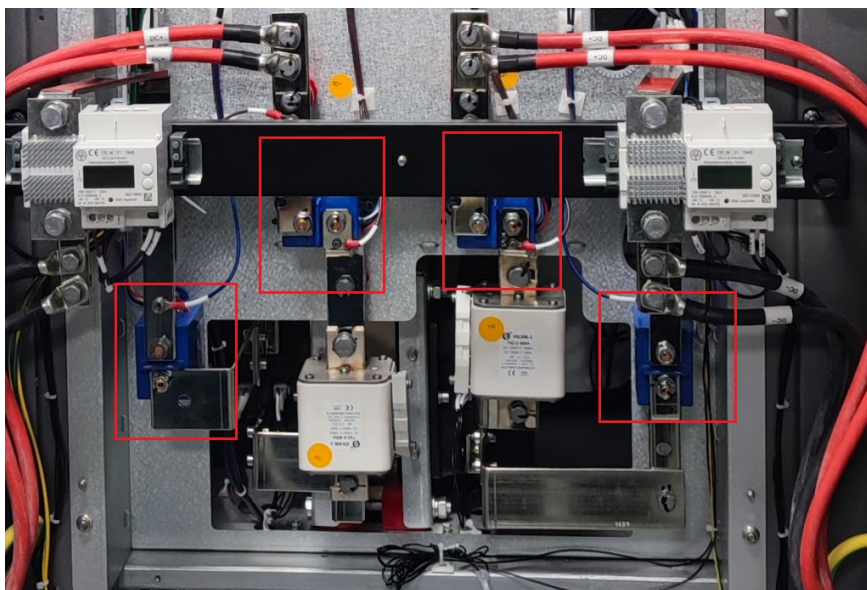

- 2) Connect output replay in web panel manually. Measure whether there is 12V to control the output relay. If not, replace the A7 board. If there is, test the continuity with multimeter. Replace the broken one.

Debug

Type	Parameters	Control
Gun Lock	<input type="text" value="Gun Id"/>	<input type="button" value="Open"/> <input type="button" value="Close"/>
Gun Relay	<input type="text" value="Gun Id"/> Example : K1 or K2	<input type="button" value="Open"/> <input type="button" value="Close"/>

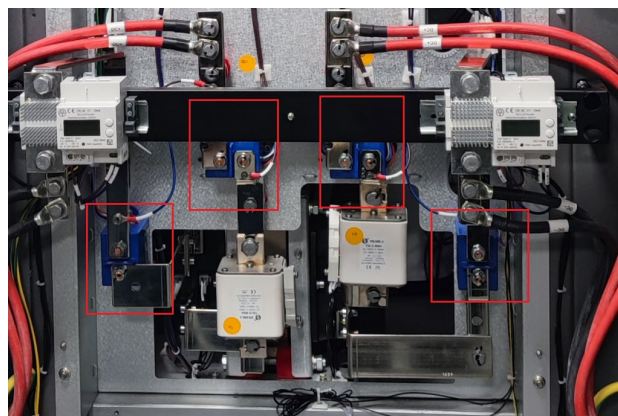

L	XT4	R
WH2-16	1	UR2-12V
Router-VCC	2	KM2-A1
	3	KM3-A1
PDU2:J1-1	4	KM4-A1
CB11-J2-12V	5	KM5-A1
CB02:J1-2	6	
CB10-J2-12V	7	KA4-11
WH2-RJ12-2	8	
WH2-RJ12-1	9	CB01:J2-6
WH2-RJ12-3	10	CB01:J2-4
WH2-RJ12-6	11	CB01:J2-5
Router-0V	12	UR2-COM
CB02:J9-1	13	CB03:J11-17
CB02:J9-3	14	CB03:J11-18
CB02:J12-1	15	CB03:J11-19
CB02:J12-3	16	CB03:J11-20
WH2-17	17	CB02:J1-1

- 3) Test the continuity of fuse protector with multimeter. Replace the broken one.

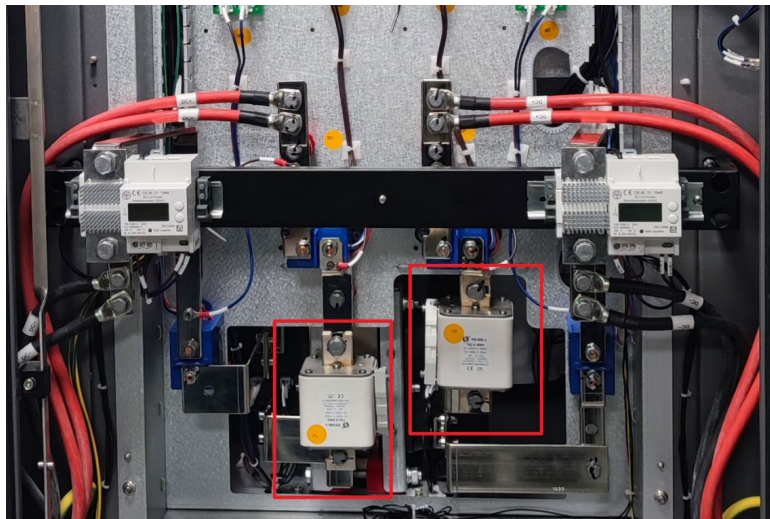

- 4) Monitor the status of power modules during charging and replace the abnormal one.
5) Find another EV for testing.

5.2.13 No response after plug in

Phenomenon:

No response after plug in

Analysis:

- 1) Something wrong with the charging connector;
- 2) Abnormal CP voltage;
- 3) Abnormal line connection of SECC board;

Solution:

- 1) Check whether there is water, stone or something inside the charging connector. If so, clean or dry it;
- 2) Measure the voltage between CP and PE when the charging connector is standby, 12V normally. Measure the voltage between CP and PE inside of EVSE when plug in, 9V normally. If the voltage is normal, check the wiring on SECC board. Correct it or replace the SECC boards;

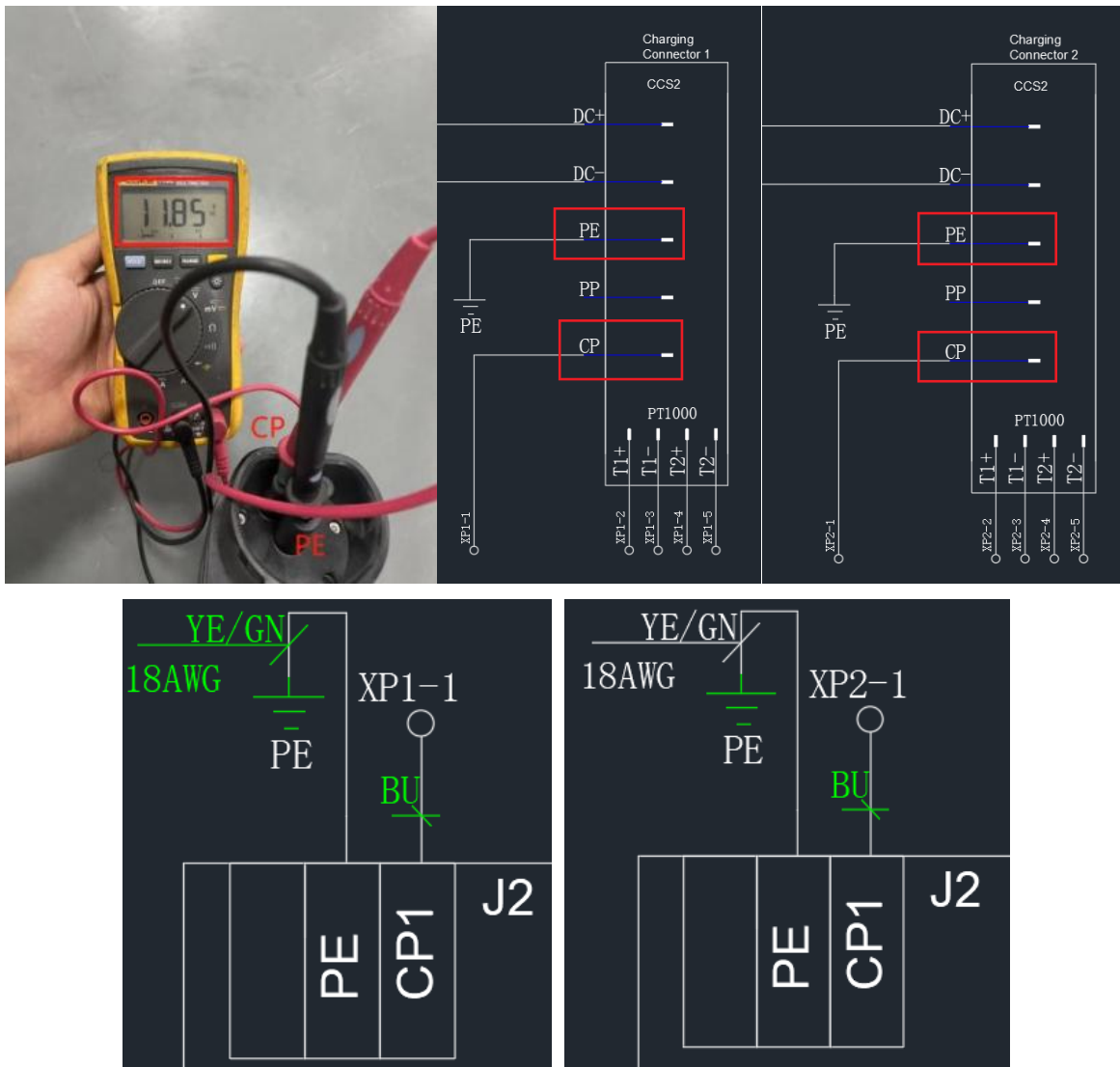

- 3) Measure the resistance between PP and PE, 1.45kΩ normally. If abnormal, replace the charging connector.



4) Check the wiring between SECC and M4 board.

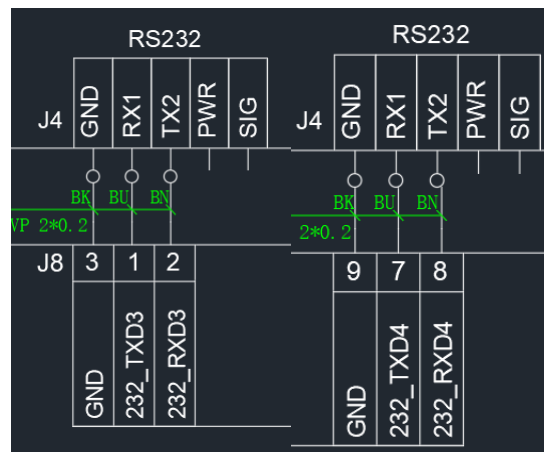

5.2.14 No response after swipe RFID card

Phenomenon:

No response after swipe RFID card

Analysis:

- 1) Wrong configuration;
- 2) UID of RFID card is not uploaded in backend;
- 3) Incompatible format
- 4) Card reader is broken

Solution:

- 1) Check the configuration in web panel;

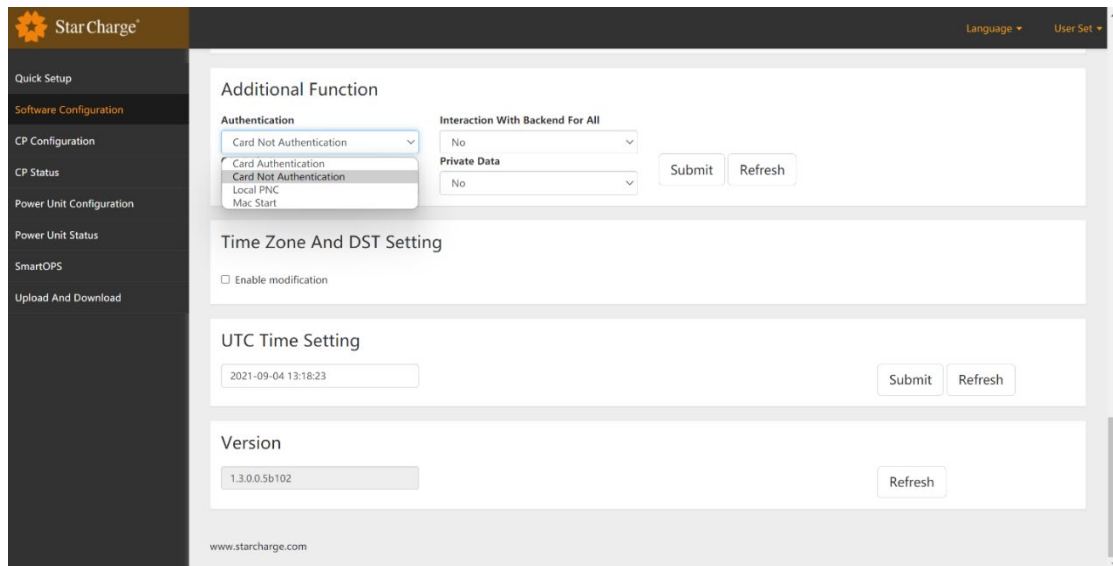

The screenshot shows the Star Charge web interface with a dark sidebar on the left containing navigation links: Quick Setup, Software Configuration (highlighted), CP Configuration, CP Status, Power Unit Configuration, Power Unit Status, SmartOPS, and Upload And Download. The main content area is titled 'Additional Function' and contains three sections:

- Authentication:** A dropdown menu is open, showing options: Card Not Authentication, Card Authentication (selected), Card Not Authentication, Local PNC, and Mac Start. To the right, there are two more dropdowns: 'Interaction With Backend For All' (set to No) and 'Private Data' (set to No). 'Submit' and 'Refresh' buttons are present.
- Time Zone And DST Setting:** A checkbox labeled 'Enable modification' is currently unchecked.
- UTC Time Setting:** A text input field contains '2021-09-04 13:18:23'. 'Submit' and 'Refresh' buttons are present.
- Version:** A text input field contains '1.3.0.0.5b102'. A 'Refresh' button is present.

The footer of the page displays 'www.starcharge.com'.

- 2) If EVSE is set in “Card Authentication” mode, make sure UID of RFID card is uploaded in backend by backend supplier;
- 3) Place the RFID card before card reader area for 2s and then remove it.
- 4) Replace the RFID card reader.
- 5) If the issue still, send the log file and the specification of RFID card to Star Charge for analysis.

5.2.15 No 230V input

Phenomenon:

Display and boards inside are off.

Analysis:

- 1) No input power;
- 2) Breaker is tripped;
- 3) Switch mode power supply is broken.

Solution:

- 1) Check whether there is 400V input power. If not, contact the installation team.
- 2) Check whether there is output voltage from breaker. If not, replace the breaker.

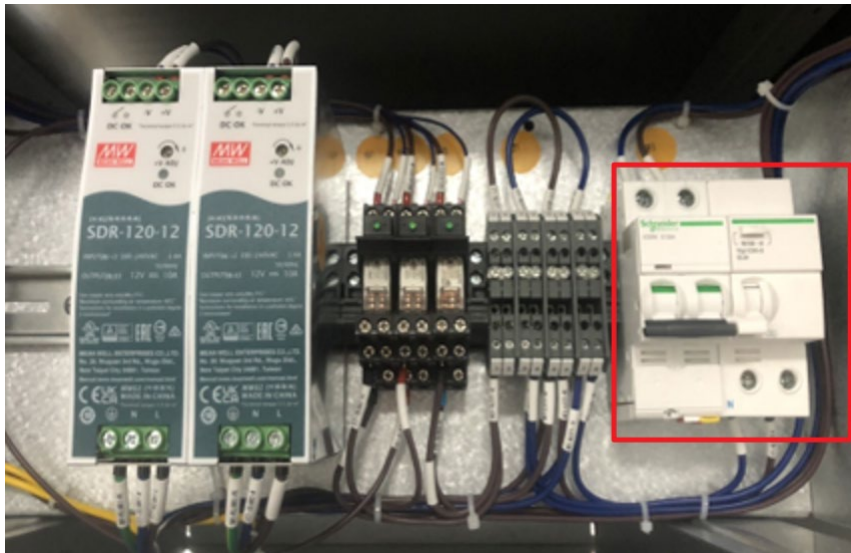

- 3) Check whether there is input and output voltage from switch mode power supply. If not, replace the switch mode power supply.

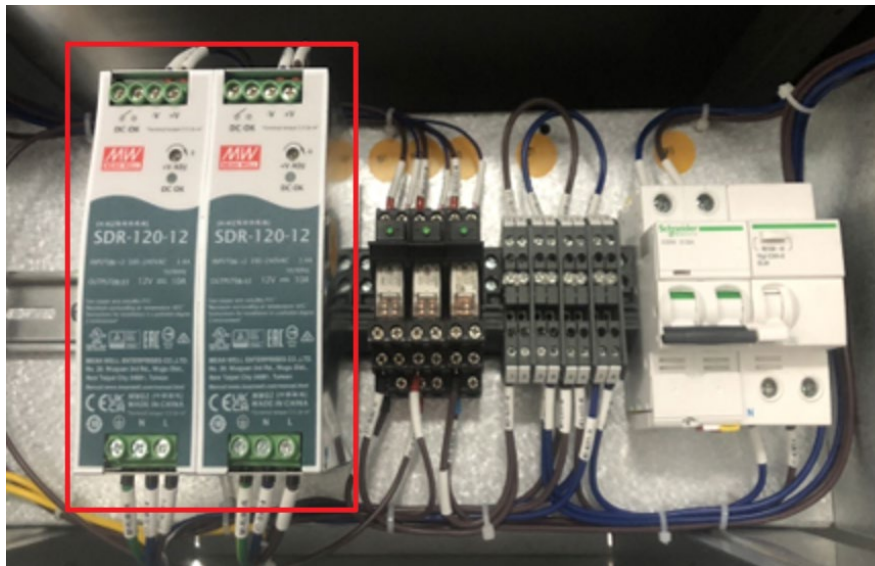

5.2.16 Display is not working

Phenomenon:

Display is not working.

Analysis:

- 1) No input power;
- 2) Poor connection;
- 3) Display is broken.

Solution:

- 1) Follow steps in “No 230V input” to check whether is input power for display.
- 2) Replace the communication cable;



- 3) Replace the display.

5.2.17 PDU Fault

Phenomenon:

“PDU relay control fault” or “PDU communication fault” is shown on the display

Analysis:

- 1) Poor connection;
- 2) PDU is broken;
- 3) PDU control board is broken.

Solution:

- 1) Check the wiring on the PDU;

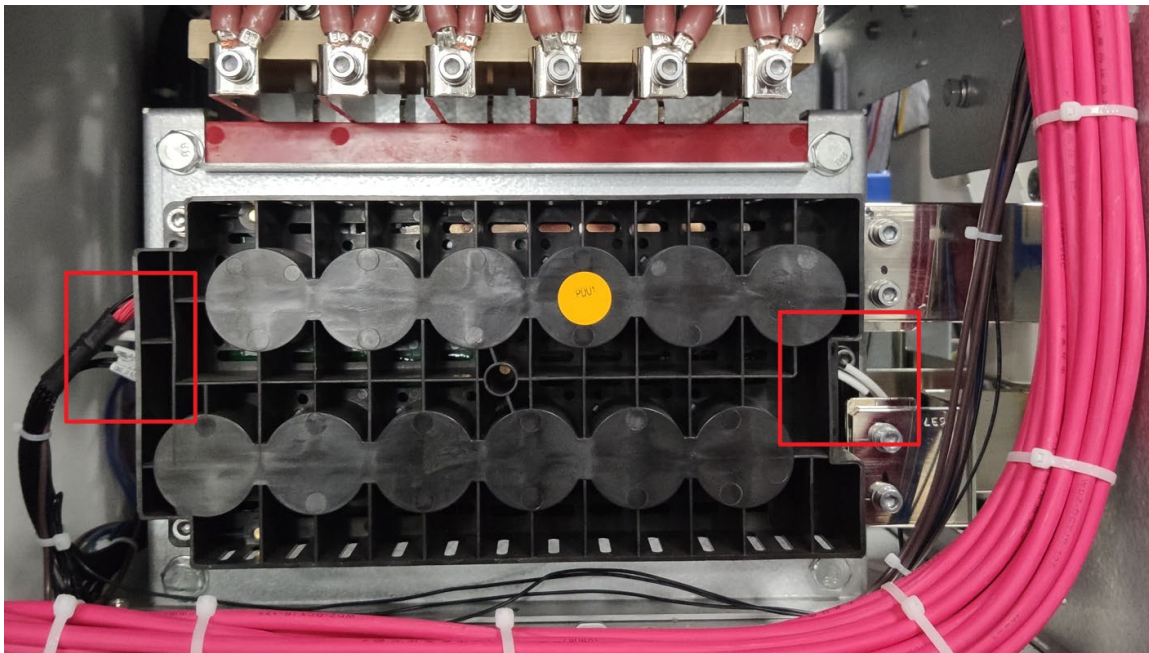

2) Connect relays of PDU in web panel to test all the relays are workable or not;

Success

Type	Parameters	Control
Fan Relay	\	Open Close
Fan Speed	Example : 0-100	Submit
AC Relay	\	Open Close
PDU Relay	1 Relay Id	Open Close
Power Check	Gun Id Request Voltage(V) Request Current(A)	Start Stop

OK

PDU Module1

Basic

Addr	1
Temperature(°C)	37
RelayBack1-3	11- 11- 11
RelayBack4-6	11- 11- 11-

3) If some relays are not closed after the configuration. Test the continuity with a multimeter.

PDU Module1

Basic

Addr	1
Temperature(°C)	36
RelayBack1-3	11- 11- 01
RelayBack4-6	11- 11- 00

- 4) If the actual situation is as shown in web panel, check the connection of “PDU control” and “PDU auxiliary contact point feedback”. Fasten the lines are loosen.

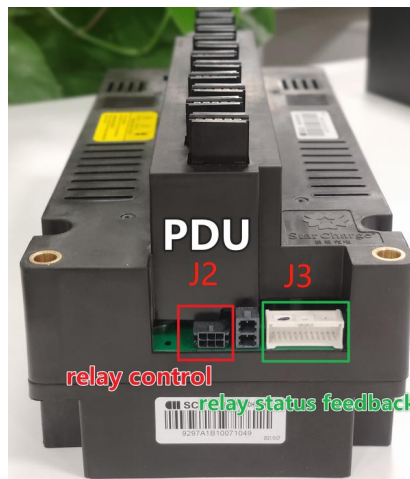
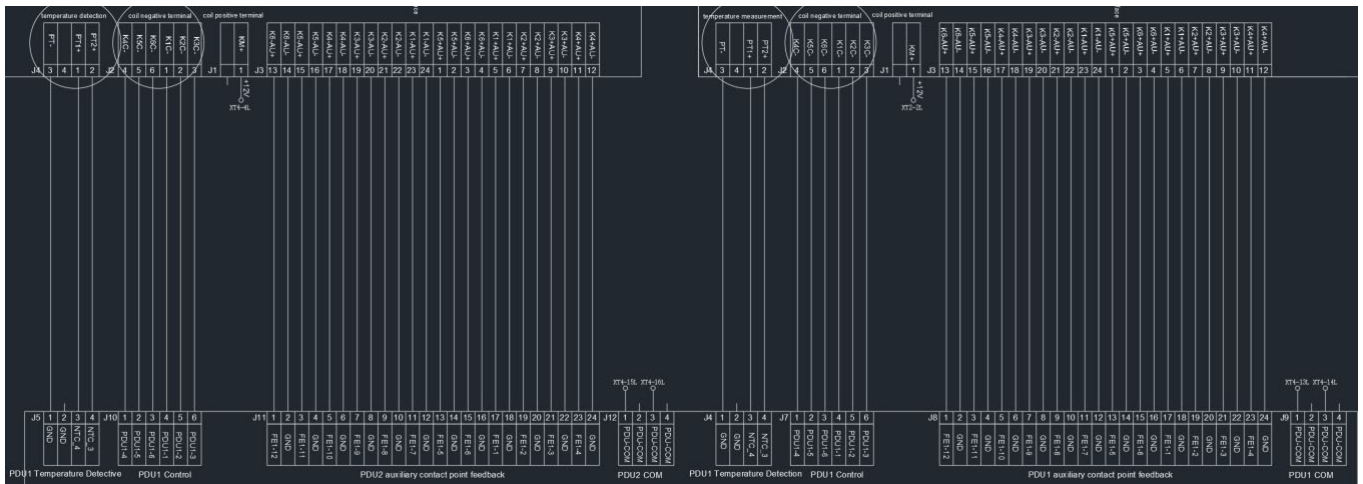

- 5) If the lines are workable, replace the PDU.
 6) If the issue still after the replacement of PDU, replace the PDU control board.